

DOHRNII

Learn. Earn. Invest. Create.



DISCLAIMER

The purpose of this whitepaper is to present Dohrnii - a **Financial Empowerment** platform.

Dohrnii's objective is to give anyone an opportunity to become financially independent. Through a gamified learning process (**learn-to-earn**) and by providing a **no-code finance** platform, where users can use automated algorithm building tools and layer on smart contracts, the objective of the platform is to educate and support the success of crypto investors.

We are looking for people who share our vision to drive this project to fruition by joining the Dohrnii Community in connection with the proposed Dohrnii Token Launch, or "Initial Coin Offering" ("ICO") and Crowdsale.

The information set forth below should not be considered exhaustive and does not imply any elements of a contractual relationship. Its sole purpose is to provide relevant and reasonable information to potential utility token holders in order for them to determine whether to undertake a thorough analysis of the company with the intent of acquiring Dohrnii (DHN) Tokens.

Nothing in this whitepaper shall be deemed to constitute a prospectus of any sort of a solicitation for investment, nor does it, in any way, pertain to an offering or a solicitation to buy any securities in any jurisdiction. The document is not composed in accordance with, and is not subject to, laws or regulations of any jurisdiction which are designed to protect investors.

Certain statements, estimates, and financial information contained within this whitepaper constitute forward-looking, or pro-forma statements, and information. Such statements or information involve known and unknown risks and uncertainties which may cause actual events or results to differ materially from the estimates or the results implied or expressed in such forward-looking statements.

AGENDA

4	ABSTRACT
7	INDUSTRY OVERVIEW
8	PROBLEMS AT A GLANCE
9	THE SOLUTION
11	EDUCATION FEATURES
13	INVEST FEATURES
21	THE ECOSYSTEM
22	ROADMAP

ABSTRACT

With the value of over 80% of the global currencies gradually decreasing, and the economic challenges the world has recently encountered, our economic reality is bound to change over the following decades. Some say the reason for this reality lies within the power of central banks and their ability to uncontrollably print money, which, when coupled with the lack of a naturally regulating mechanism (like the disbanded gold standard), results in high inflation rates. This lack of a sustainable monetary mechanism has led people to start exploring alternatives to holding their savings in traditional bank accounts.

The market shifts are already at hand. People are increasingly looking for alternatives to saving in the form of investing - be it in real estate, stocks or cryptocurrencies. While years ago investing was only accessible through an intermediary party such as brokers, the situation has dramatically changed. Today, digital platforms that enable people to invest anywhere and at any time on their own are surging in popularity.

The advent of cryptocurrencies and the rising interest in them as a form of investment has become another viable alternative to fiat and stocks. Cryptocurrencies like Bitcoin, albeit volatile, are immune to inflation due to their limited supply.

While the shift is evident and investing in stocks or cryptocurrencies has become widely accessible to most, a series of challenges still remain.

Dorhnii focuses on two of these challenges:

1. Lack of Financial Education
2. Lack of tools to support retail investors.

Dorhnii aims at solving these challenges by building a Financial Empowerment platform that has two main objectives - **first**, it aims at providing financial literacy to everyone through a gamified education feature; **second**, it looks to support investors by simplifying the creation of AI alerts, smart notifications and algorithm building.

Dohrnii has, thus, two main features:

- **Educate**
- **Invest**

The Educate feature uses a **learn-to-earn** system, which rewards users as they progress through the lesson modules.

Users will go through Quizzes and Challenges to test their knowledge and get a chance to win prizes.

This feature will act as a funnel to drive user growth into the platform.

The Invest feature will develop a decentralised **no-code algorithm building** tool and facilitate access to market insights using high quality datasets, while simplifying the deployment of tailored AI alerts and smart notifications for the user.

By introducing smart contracts, the platform opens the door to a user-generated ecosystem where creators build and monetise their products, while retaining ownership and control over the access. The use of smart contracts enable trustless interaction between people that want to consume data and people that create the data.

The no-code algorithm building tool will use blocks of logic in plain English that the user can add together to create a series of trigger events. These will support investors by automating certain types of strategies. This approach can help investors reduce losses and increases profits.

Example of logic blocks:



Dohrnii will issue its own token, the DHN token. It will be used as a utility token on the Dohrnii platform. Use cases for DHN are across both features:

- “Educate” use cases: rewards from quizzes; unlocking challenges; unlocking lessons and modules, in-app purchases.
- “Invest” use cases: paying for trading fees; paying for access to automated tools and notifications; discount on trading fees; staking rewards; rewarding validators and moderators.

The non-profit Dohrnii Foundation, incorporated in Switzerland in early 2021, is responsible for building, supervising, and accelerating the growth of the Dohrnii ecosystem. One of the core beliefs of the Dohrnii Foundation is that **Financial Education is a Human Right**.

The mission is clear - to empower every investor by growing their knowledge and ability to act, and giving them access to a wide arsenal of tools to maximising their returns.



INVESTMENT INDUSTRY OVERVIEW

Investing as the alternative to saving

Today, investing has become the better alternative to keeping your money in the bank. Indeed, interest rates have hit a rock bottom and with various macroeconomic factors such as inflation pushing down the leverage even lower, people have started to look for alternatives. According to a research in 2020, almost one-third of American adults have investments outside of their retirement accounts.

The rise of online trading platforms

With the increased global rate of digitization, the easier access to investment platforms and the macroeconomic situation unfolding over the last 12-15 years, the interest towards investing online has greatly increased over the last decade. High popularity of cryptocurrency trading could play an important role in the advancement of the global online trading platform market.

Algorithmic trading market

A natural development of online investing that has been rapidly gaining popularity over the last years is the algorithmic trading market. While the computerisation of stock market trading began approximately half a century ago, major advancements in AI and machine learning over the last years have pushed this much further. In the U.S. stock market and many other developed financial markets, about 70-80 percent of overall trading volume today is generated through algorithmic trading.

The harsh reality about trading

With the rising number of people deciding to take on investing, the percentage of newcomers who are unsure about how to approach investing in general is also increasing. This leads to another problem – an ever decreasing percentage of profitable traders. You have probably heard the saying that more than 90% of all traders lose money. In fact, there is no research to confirm this statement, but it is suggested that in reality, the percentage is even higher.

PROBLEMS AT A GLANCE

Lack of Financial Education

Financial literacy is important because it equips us with the knowledge and skills we need to manage money effectively. Without it, the financial decisions and the actions we take—or don't take—lack a solid foundation for success. And this can have big consequences.

- Nearly half of Americans don't expect to have enough money to retire comfortably.
- Credit card debt has reached its highest point ever.
- Forty percent of Americans can't afford a \$400 emergency expense.

Lack of tools to support crypto investors

Investing in crypto projects is still at its infancy, there are very limited tools that investors can leverage to gain insights and optimise decision making.

Retail investors also account for a significant percentage of crypto investors, especially when compared to other type of investment products.

However, these investors do not possess the right tools to efficiently manage their due diligence process and automate part of their strategies.

This is partly due to the fact that there exist no platform with a user interface that is friendly enough so that anyone can use it.

THE SOLUTION

FINANCIAL

LITERACY
EDUCATION
FREEDOM
EMPOWERMENT

 DOHRNII

DOHRNII

The objective of the Dohrnii Foundation is to create a decentralised platform that solves two of the biggest challenges in the crypto space: education and access to advanced tools.

FINANCIAL EDUCATION IS A HUMAN RIGHT

First, give them
the education

Then, give them
the tools

LEARN



- Gamified approach to learning
- Learn-to-earn with the Dohrnii academy
- Play quizzes to win DHN rewards
- Challenge other users to earn DHN
- Create an investor profile for tailored content
- Learn about investment concepts and strategies

IMPLEMENT



- Create tailored smart notification push
- Create no-code algorithms based on trigger events
- Track and monitor projects using AI tools
- AI market analysis based on specific indicators
- Copy or adapt the investment strategy of successful investors

“GIVE A MAN A FISH AND YOU FEED HIM FOR A DAY.
TEACH HIM HOW TO FISH AND YOU FEED HIM FOR HIS LIFETIME”

EDUCATION FEATURES

Through the Dohrnii Academy, our objective is to give users tailored content that match their profile and make it fun and engaging to learn about investment concepts.

STRATEGIES & CONCEPTS

Investor questionnaire: Evaluate your investor profile to gain insights into the top strategies for your profile.

Strategies: Based on a user's "Investor Profile", this feature will give tailored information to support the success of the user and help them avoid some blunders while leveraging on some of the most success people and strategies.

Concepts: These are short descriptions about major investment concepts. Users will come across "Concepts" separately throughout the app.

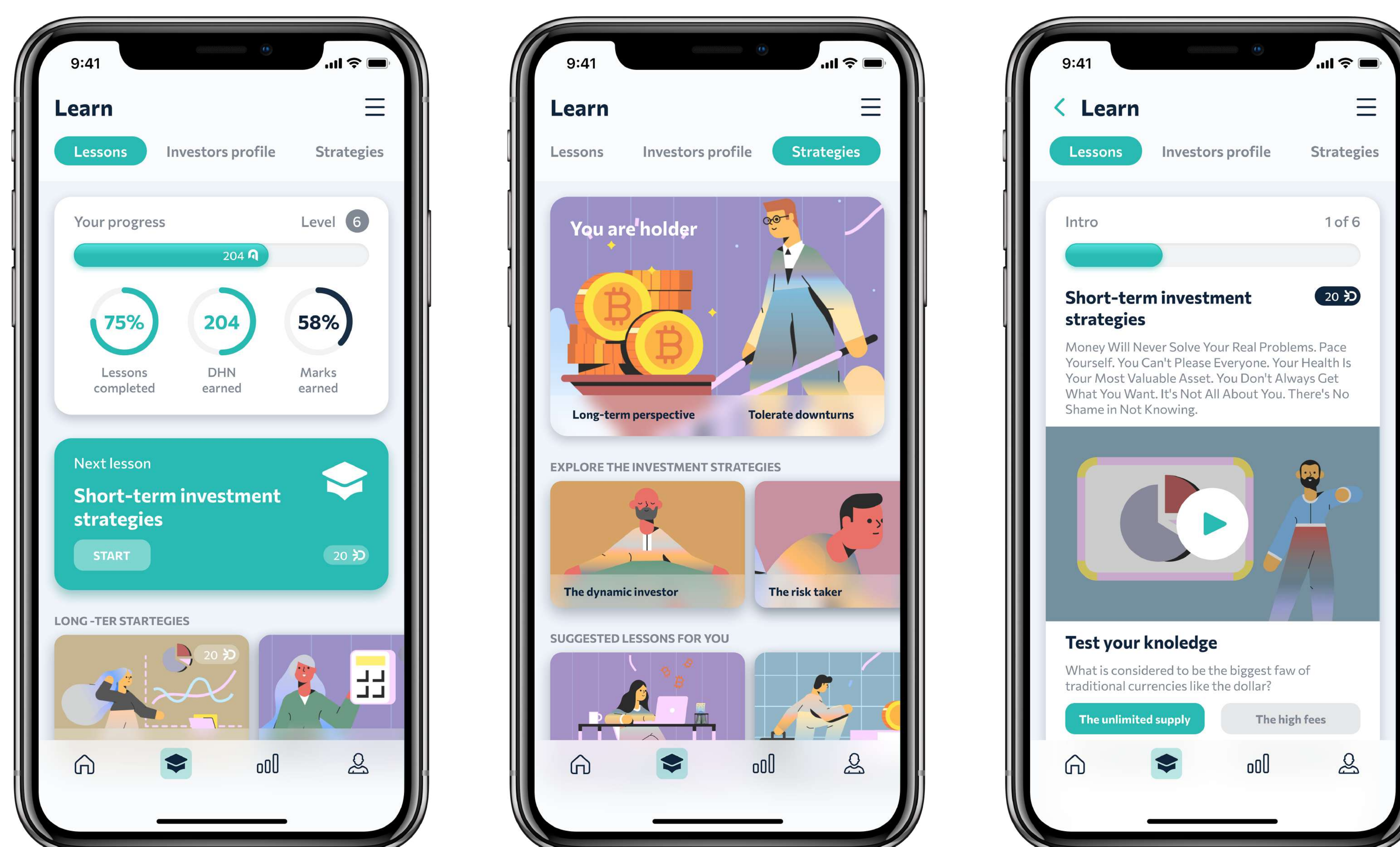

LESSONS

The Dohrnii lesson feature is a gamified approach to learning. Dohrnii introduces a **learn-to-earn** model where users get rewarded after successfully completing lessons and quizzes.



Gamifying the Learning Process

The objective of Dohrnii is to make the learning process as engaging as possible. We want users to have fun while learning.

To do so, we will introduce “Tests” and “Challenges” that users can take part in.

These Tests and Challenges are unlocked by progressing through the lesson modules and give users a chance to win prizes such as DHN, BTC or ETH tokens.

Tests & Quizzes

These are individual sessions. They are timed and randomly select topics from previous chapters. Similar to “Who wants to be a Millionaire” there will be questions, a clock ticking, and if completed correctly will unlock rewards.

Challenges

Challenges are multi-player sessions. Users can test their knowledge against each other to unlock DHN prizes and other perks.

These challenges can take many forms, such as time sensitive quizzes, content creation challenge, heads-up challenges...

INVEST FEATURES

Dohrnii aims at **reducing the friction** between information and action.

Friction exists partly because of a lack of tools available to retail investors. These tools could make collection, cleaning and sorting of data quicker and more efficient for the user. The invest feature bridges the gap between data and the crypto ecosystem by creating an interface where people can freely create and distribute data while keeping ownership of the "data-set" produced.

The current process to create datasets and automated strategies is very complex and requires strong understanding of coding and programming languages.

Dohrnii's objective is to create a **NO-CODE FINANCE** platform

A simple API call and a get request (requesting data)



```
19 final_dataframe = pandas.DataFrame (columns = my_set)
20
21 for symbol_string in symbol_strings:
22     batch_api_call_url = f'https://xxx{symbol_string}'
23     data = requests.get (batch_api_call_url)
24     print(data.status_code)
25     for symbol in symbol_string.split(','):
26         pass
```

The Current process

Web Scraping
Data Harvesting
API Tokens



Programming Language
pandas dataframe
other dependencies



Dependencies & librairies
python language compatibilities
API calls & tokens
Back testing & custodian services

Collection

Clean & Sort

Dataset 1

Dataset 2

Dataset 3

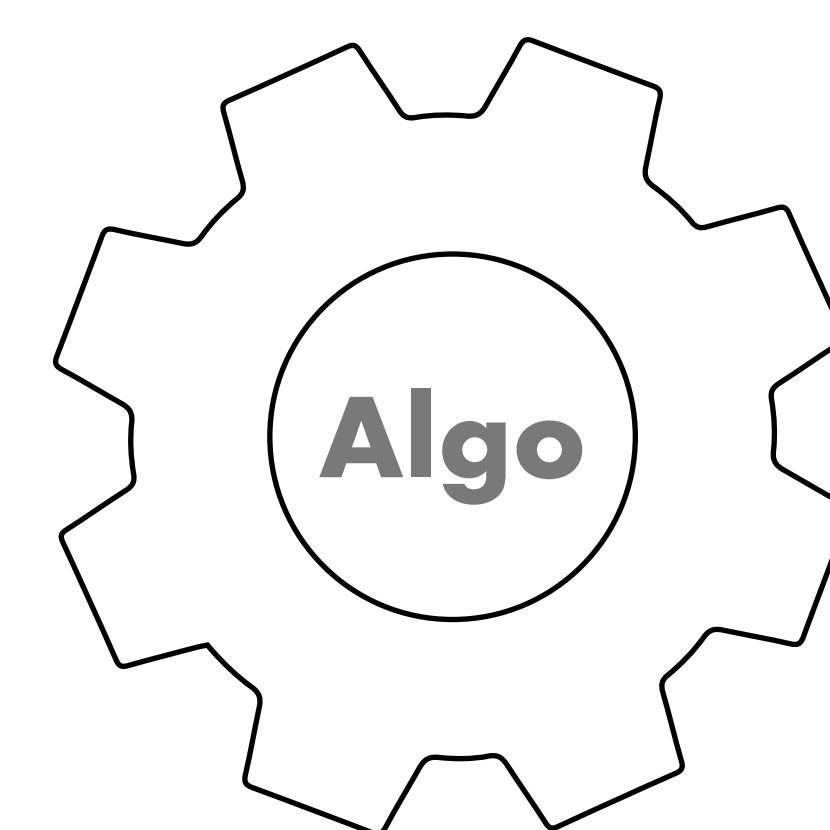

DOHRNII

Front end platform with simple-to-use tools.
Virtual environment preset with dependencies.
Easy click and select user interface.
Ready made language compatibility in the backend, which the user doesn't need to see or know about e.g. pandas, numpy, json, math..

NO-CODE FINANCE

Datasets

Automated algorithms

Creating a dataset

Dohrnii's smart contracts enables data creators to track and monetise their dataset.

This protocol incentivises the creation of high quality datasets as the market will reward the owner with high number of transactions.

On the other hand, users can also freely consume data by unlocking datasets using the native token of the platform

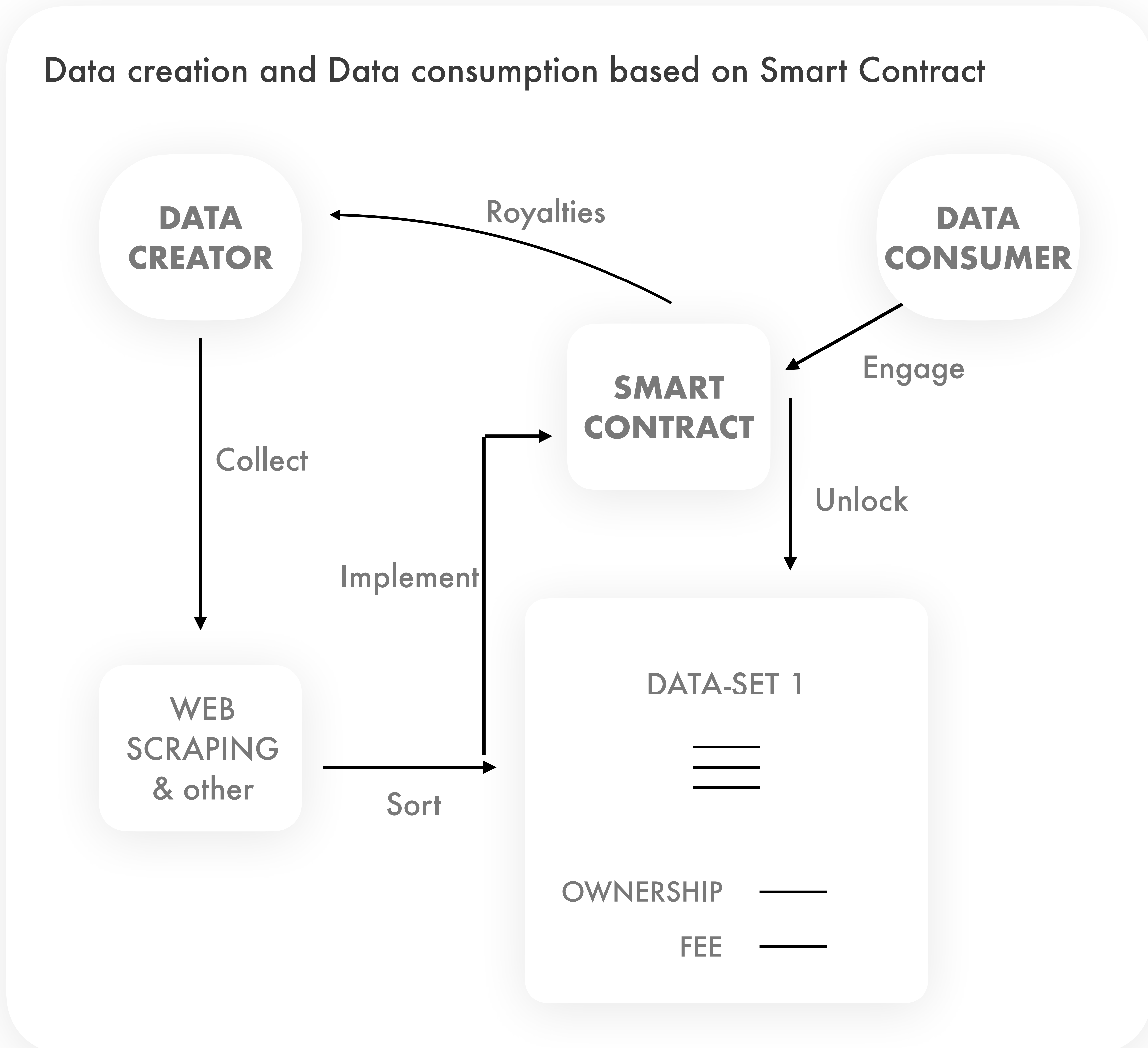

An ecosystem for "investment data" and automated strategies

Data Creators and Data Consumers

Creators: Simplify access to data by scrapping, cleaning and sorting datasets

Consumers: Get access to high quality data and datasets

Creators: They maintain ownership of the dataset and I are able to monetise it.

Consumer: Get access to two types of data: real-time data and historical data, static.

Sample Dataset (Community metrics)

REAL-TIME UPDATED	Community Growth Rate	Engagement Ratio (Likes / follower)	Sentiment Ratio (Positive / total)	Community Score 0 - 50
Project 1	20%	10%	47%	21
Project 2	10%	40%	75%	42
Project n	5%	20%	60%	26

Data Access & Permissions

Dataset access could be perpetual (as many times as you like), time-bound (access for one day, one week...), or one-time (after accessing once, access is blocked)

Type of Data

Data access within the platform will be based on authorised signature where data is viewed as a service. This could be a service to access a static dataset (e.g. a single file), a dynamic dataset (real-time value), or any other form.

For static data, users can adapt the method based on the type of storage: Web2 cloud (e.g. AWS), Web3 non-permanent (e.g. Filecoin), Web3 permanent small-scale (e.g. Ethereum), Web3 permanent large-scale (e.g. Arweave), or go meta using IPFS.

For dynamic data, include Web2 streaming APIs (single-source), Web3 public data oracles (e.g. Chainlink), and Web3 private data oracles.

Consumers will use the platform in order to:

- Get due diligence support
- Track and gain market insights in real time
- Automated trades
- Downside protection
- Follow other investment strategies

Creators will be able to:

- Monetise their datasets
- Monetise on the investment strategies
- Retain ownership
- Privacy and security
- Digital rights management

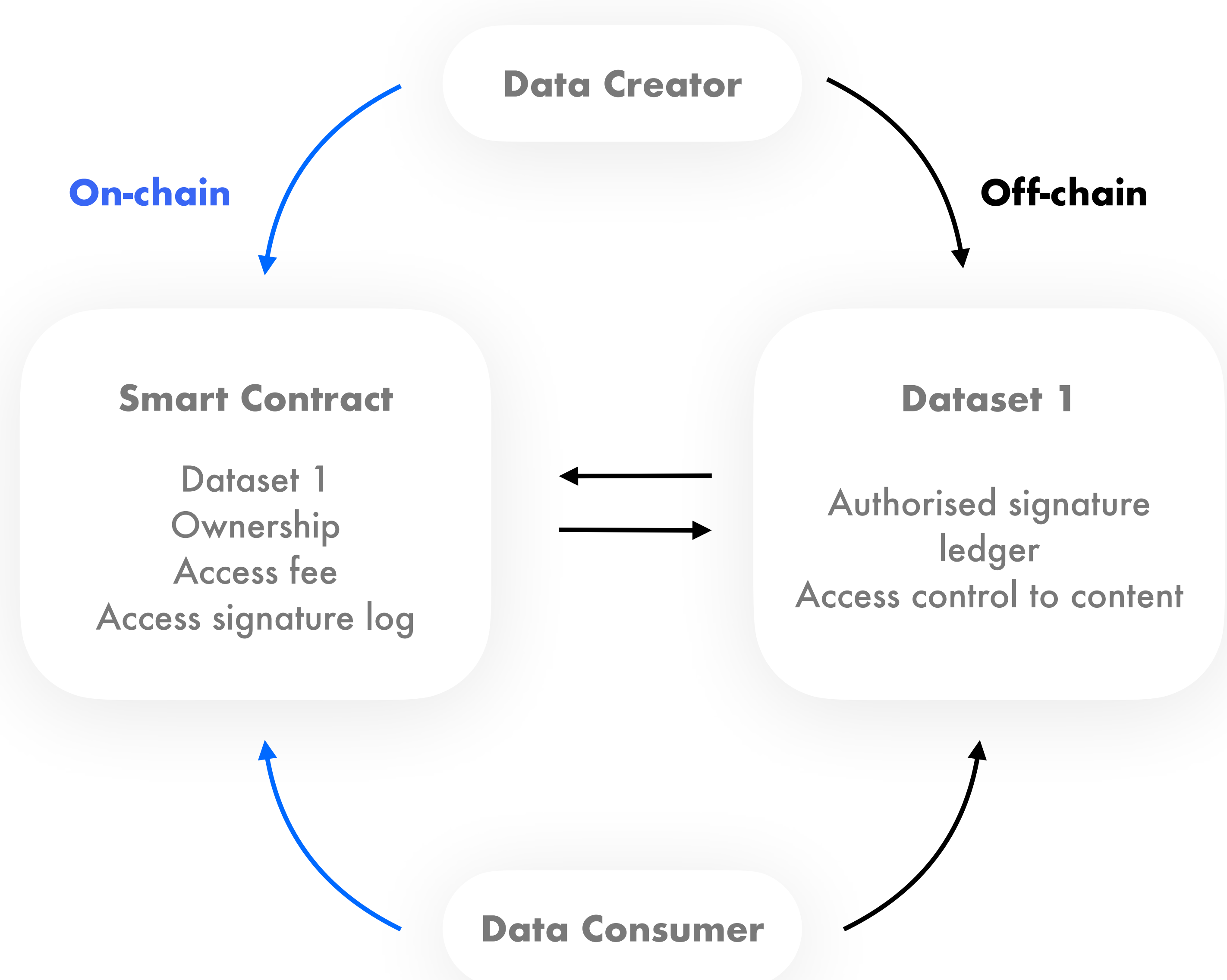

Due Diligence Support

E.g. : Assume a user wants to study the growth of two projects by tracking the growth of their respective communities. The user is looking for the number of social media followers over the last 2 years for project A and B.

A data Creator has this data; he has been tracking the number of social media followers of over 1,000 different project in the last 3 years and has this data-set available.

The creator and the user are now able to trade with confidence using a smart contract which unlocks the content on a specific basis (one-time only; for x amount of days; perpetual..)

Real-time tracking

E.g. : As an addition to the previous example, a user might want to track the number of followers in real time to better spot a trend arising.

The user is looking for the best proxy for community growth.

A creator has a dataset which tracks several factors in real-time from the community, such as:

- Community engagement (ratio of likes to number of follower)
- Community sentiment (ratio of positive vs negative comments)
- The creators also creates a proprietary "Community Score" indicator.

The creator and the user can now interact with confidence using a smart contract which provides specific access to dynamic data to the user on specific terms

Combining "Datasets" to create "Logic Blocks "

Another feature that will be deployed on the platform is a user interface to build logic blocks in plain English.

By combining datasets together and including an action item, automated strategies can quickly and easily be created.

Logic blocks and dataset integration and automation

IF DATA-SET 1 | Fn = DATA-SET 2 | Fn

AND DATA-SET 3 | Fn > DATA-SET 4 | Fn

OR DATA-SET 5 | Fn < "VALUE"

THEN API CONN. URL

+ IDENTIFY NAME

+ INITIATE BUY / SELL

The aim is to spread the benefits of AI by giving easy access to high quality data, while allowing creators to monetise and retain ownership of their data.

Automated Trades

E.g. : A user could want to automatically initiate a trade in case one or multiple events happen. For instance, if a specific coin gets listed on a specific exchange, then the user would like to get in as soon as possible.

A creator could use the automated logic block feature tool to create this specific scenario. In this case, the user would lock funds in a smart contract, with a specific data by which the contract expires if not triggered.

E.g 2: A user working on Technical Analysis (TA) believes that if MACD lines crosses below to above the signal line, then this is a bullish indication and he would like to immediately long / buy the coin. A user could use a smart contract which locks his fund until trigger / or not. This in a fully decentralised and autonomous way. No intermediaries or custodial 3rd party.

It is also possible that independent creators will build strategies and offer them for a fee or subscription based, which can all be part of the smart contract.

Creating an Automated Strategy

Using Dohrnii, Lark could create an automated strategy, which will trigger a buy if his conditions are met.

Lark could then use the Dohrnii marketplace in order to put his strategy on a smart contract and offer it to other users.

Users that want to participate would lock funds into the smart contract, with a date by which either the trigger happened, or the funds get returned to sender.

No middle-man, no custodian, **no problem**

← Tweet



Lark Davis
@TheCryptoLark

#bitcoin daily close back above the 200 day MA and golden cross confirmed.

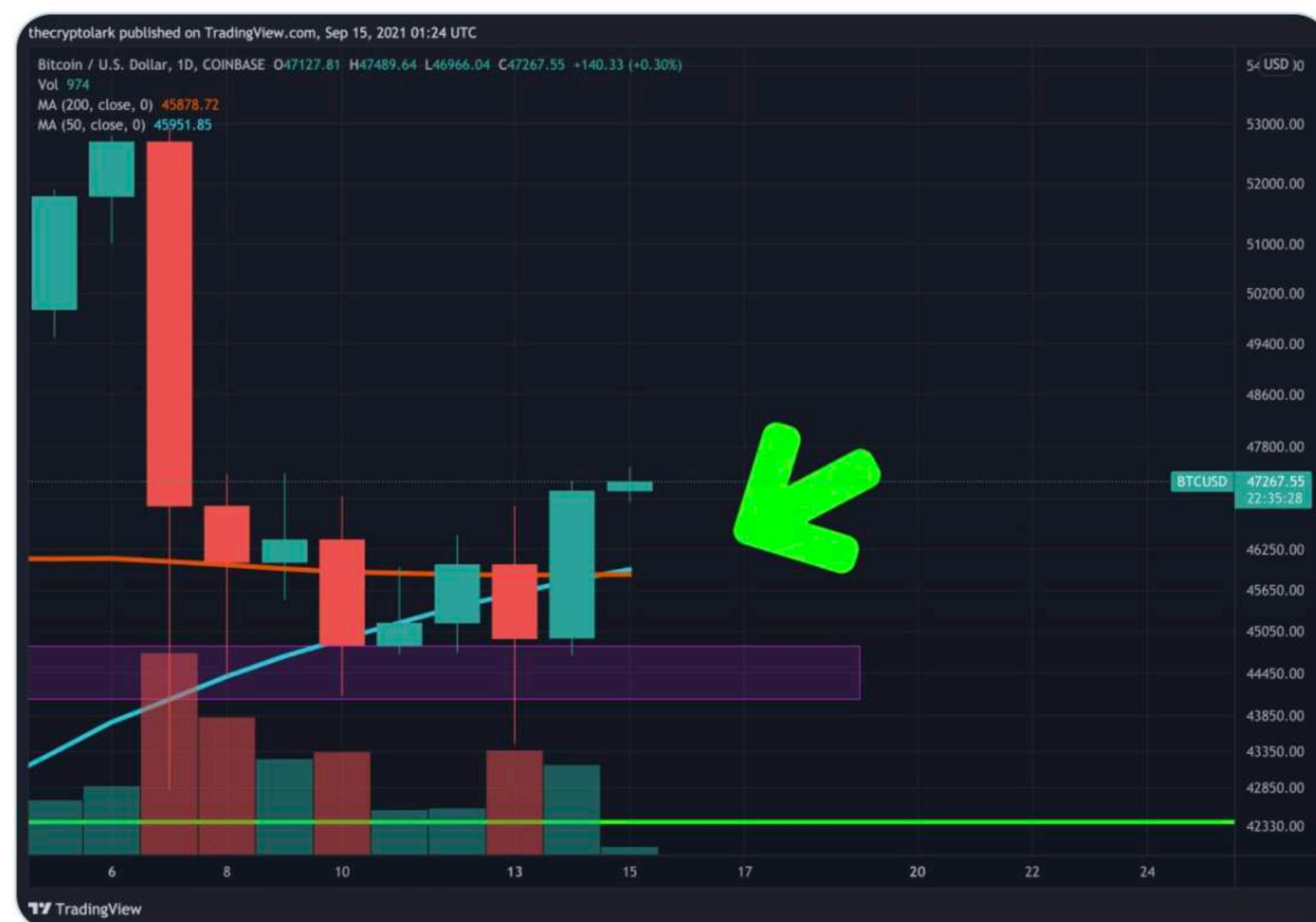

3:26 AM · Sep 15, 2021 · Twitter Web App

583 Retweets 31 Quote Tweets 4,136 Likes

Decentralised Automated Algorithm (DAA)

Users will be able to create their own DAA, or engage with existing DAAs.

By engaging with a DAA, the user lock funds in a Smart Contract which has a gas cost.

The gas cost depends on the number of variables tracked, the frequency and the cost of each DDS.

The creator of the DAA will collect a fee on the total lock fund value.

Automated Algorithms and fee calculation

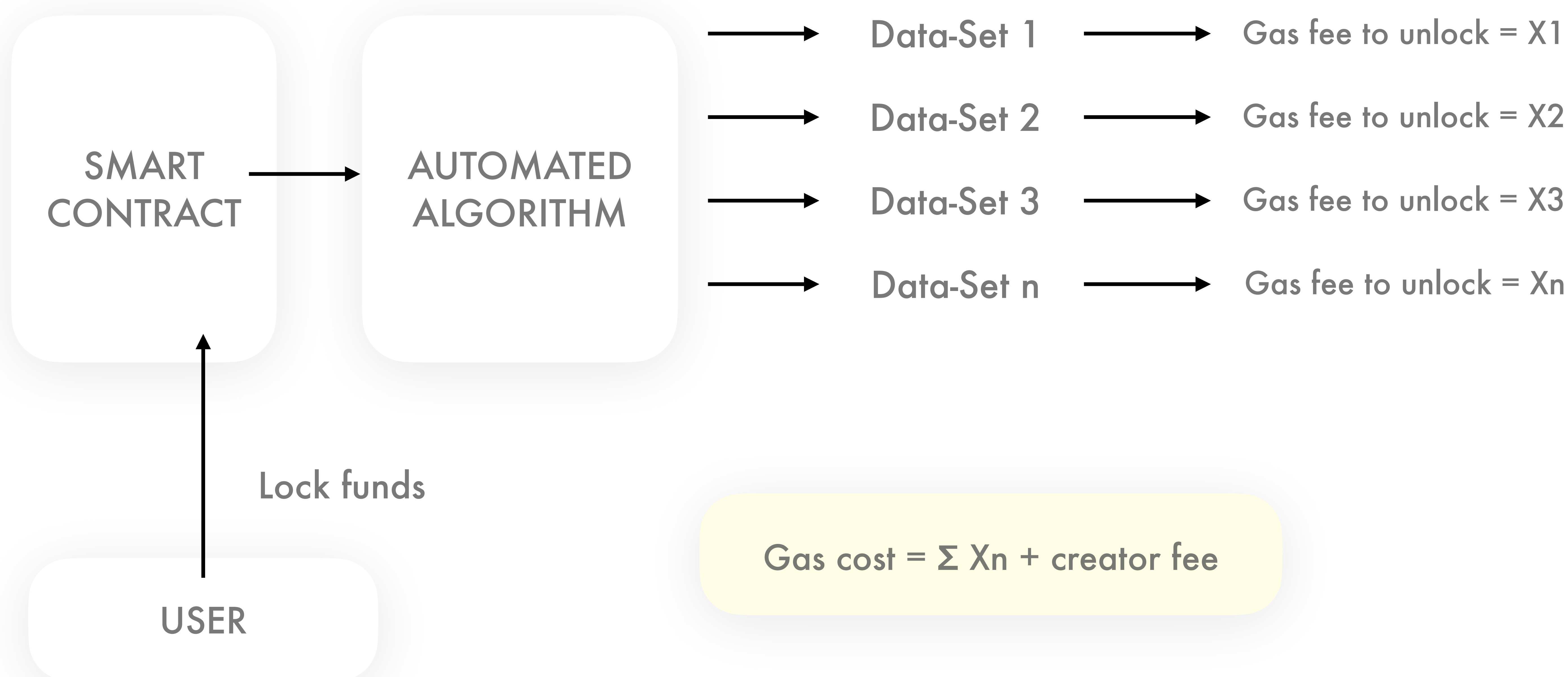

Multiple models can be derived from this process. A creator may choose to charge in the form of a subscription model, resembling Data as a Service (DaaS) models.

Leaving the door open for Subscription models

The Dohrnii platform will have a built in function which offers subscription terms between the creators and consumers, and pushes this as a subscription request to the consumer's wallet.

A subscription request containing metadata about the subscription is sent to the user to be accepted. This will initiate a smart contract relationship between the consumer and creator.

The function will automatically lock funds to the smart contract, and the creator will only be permitted to withdraw funds which have been accounted for, based on elapsed time. The consumer may choose to cancel anytime to be refunded for the remainder of the subscription interval.

Kickstarting the platform

Similar to the evolution of website and app building, which used to be only possible through writing lines of codes, these are now accessible in a friendly user interface which does not require coding.

Dohrnii wants to bring a similar experience to our users. Dohrnii will combine the aforementioned elements to give users several no-code features:

Automated alerts & notification:

- New Listing
- New Product Launch
- Partnership announcement

e.g. A user could tailor the tool to push notifications on certain types of events. The user will define the event, the source to harvest and the type of alert he receives.

AI market indicators & tools

- Community size & growth
- Community engagement & sentiment
- Product roadmap
- Company growth
- Comparative analysis

e.g. A user could leverage this tools to monitor one or multiple projects, or to complement his analysis of a project, using factors that he selected across multiple channels to track and analyse personalised KPIs.

No-code algorithm building

- Trigger event strategies
- “Logic Blocks” building

e.g. A user could create multiple automated strategies based on a different factors. Using logic blocks in plain english, the tool is easy to use and does not require coding.

Introducing Datasets

With regards to the Dohrnii platform, the dataset is a set of data that can track any variables on the internet.

By using python or even a web-scraping and data-mining software, it is easy to create a dataset tracking very large amount of data quickly.

Any website can be harvested for data, the system is also able to crawl, meaning that it can automatically change pages and navigate on the website, hence collecting further data.

Using these methods, many datasets can be created and maintained at a low cost. Automating the harvesting on an hourly, daily, weekly basis will enable users to generate analytics on the data over a defined time period.

These datasets can track anything from number of followers to partnership news and so on.

From a user perspective, using these tools, they could create multiple “indicator boards” tracking what is important to them, and generating insights over time.

Datasets aim at giving users an added layer of information to optimise their decision making.

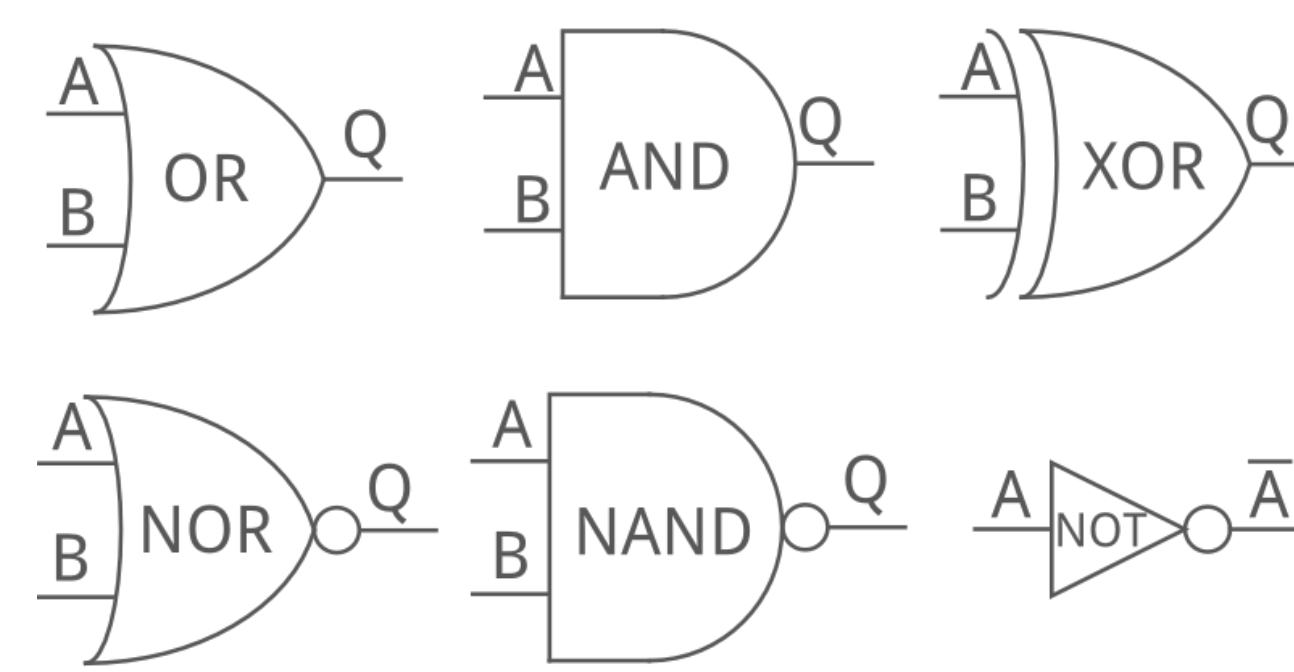
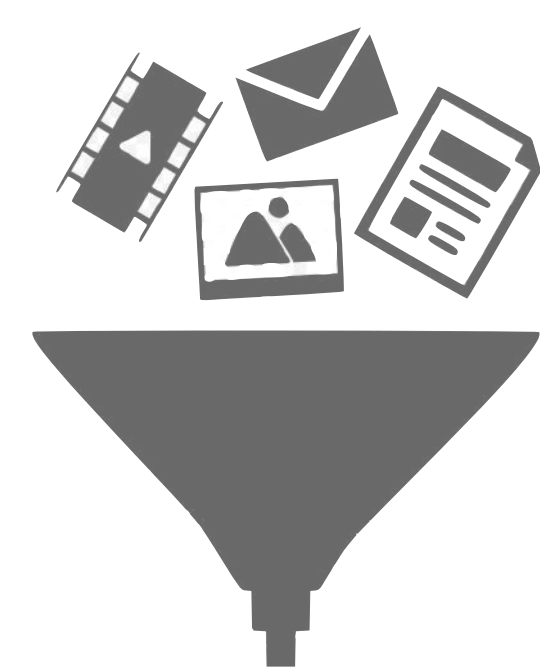

Introducing Logic Blocks

Logic blocks is a term used to describe the process in which a user creates a set of commands that are linked and connected chronologically.

This is very similar to the thought process we use in everyday life.

You might wake up and think: If it is raining today then I will take an umbrella.

Similarly, we can use the same logic to create powerful algorithms.

If this indicator crosses that indicator, then I will buy/sell.

A lot of complexity can be layered onto such a structure, and a great number of different strategies can be generated by a set data.

From the perspective of the user, they could use such tools to automate trades based on trigger events (such as a listing, a partnership announcement...).

They could use it to protect their downside in case of black swan events.

Many strategies can derive from logic block building.

The objective of Dohrnii is to make the interface easy and simple so that anyone without a coding background can create their own algorithm.

THE ECOSYSTEM

A Decentralised System - Purpose of the blockchain & smart contract in Dohrnii

By allowing for the creation of smart contracts, the objective is to make everyone a potential data creator. Leveraging on the platform's tools, they can create datasets and/or automated strategies and have them distributed in a decentralised manner while maintaining ownership and control over the access.

This opens the door to an entire ecosystem for "investment data" & strategies. There will be data consumers and data creators. In essence a marketplace where people will trade investment products in the form of dataset and automated strategies.

The value-add of a decentralised system is that it does not require trust to engage with it; there is a direct peer-to-peer transaction with no middleman; while at the same time providing privacy, security, ownership and control; which leads to monetisation opportunities for creators.

Introducing the DHN token

Objective of the token

DHN is an empowerment token. It will be used to reward users and market participants as they engage with the network.

DHN powers the decentralised DOHRNII platform by incentivising participants across all aspects of the project.

Use case of the Token

DHN is a utility token and has several use cases

- DHN will be distributed to users as the completed tests and quizzes
- DHN can be used to participate in a challenge against other users.
- DHN can be used for in-app purchases
- DHN will be used to pay for access to automated tools
- DHN will be used to pay fees from data insight
- DHN will be used to engage with smart contracts

Maintaining the Network

Maintaining the network along with the datasets & logic blocks will be initiated by the Dohrnii foundation, however, to create a sustainable model, the system needs to be open to participants. Participants will take the form of **Validators and Moderators (V&Ms)**

V&Ms will be incentivised to participate and keep the network running and updated.

The platform will reward V&Ms by distributing fees collected from the platform. The fees will be collected and distributed in the platform's native token, DHN.

ROADMAP

2021

JUNE

Dohrnii.io development begins with community led initiatives

NOVEMBER

Initial features deployed on testnet v1

2022

FEBRUARY

Community access to educational and insight features

MAY

Dohrnii v1 beta launch

SEPTEMBER

Testnet v2 – focused on trading features

DECEMBER

Full platform deployment – dex and automated invest features added

 **DOHRNII**

FINANCIAL
EMPOWERMENT
PLATFORM

DOHRNII.IO